



**EARNSHAW'S**  
FENCING CENTRES



**Cabin**Systems2015

# *cabin systems*



Most of our Log Cabin kits are assembled in the UK which offers our customers great flexibility to choose either a standard building or customise where to put doors & windows, overhang of the roof, roof style and height of log cabin.



The Cabins offer superb quality at incredible value for money, and we are certain that you will find a building that will suit your requirements. All the 44mm Log & 70mm Log Cabins are double glazed as standard (excluding the garages) which adds to their outstanding value.

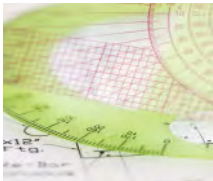

Most of the range can be customised and adapted to suit your needs at little additional cost. Window & door positions can be altered, Roof overhangs can be minimised & a pent style roof can be added on many of the buildings. You can choose to add roofing shingles, floor & roof insulation & terraces to enhance your building.



If you wish to erect the building yourself we provide clear & easy to follow installation manuals. Alternatively, if you would rather enjoy relaxing in your new space immediately, you may wish to opt for our installation service.



We offer a delivery service throughout the UK. Please ask about any delivery charges that may apply to where you live.



All of the Log Cabins are supplied untreated, with the exception of the foundation beams which are pressure treated with Tanalith E. We strongly recommend that your Log Cabin is treated within 14 days of installation.

There are a wide range of treatment products now available meaning that you will be able to co-ordinate your log cabin with its surroundings. The treatment product chosen **must** be suitable for planed timber. Any product that is not suitable for planed timber, and is only suitable for rough sawn timber should **not** be used on your Log Cabin. You will need to both treat your building with a wood preservative to protect the wood from rot or decay and weatherproof the wood using products for this purpose. These are often combined in one product but please phone us for more information and our recommended range of products.

# Summerhouses

## Radnor Log Cabin

This lovely corner summerhouse fits neatly to any **corner** of a garden, ideal for gardens where space is at a premium. Made from 28mm logs, the Radnor Corner Log Cabin comes with two side single glazed windows & roofing felt as standard. They are all 2.8m high to the ridge.

Radnor 1 Log Cabin - 2.6 x 2.6 m - with a single door to the front

Radnor 2 Log Cabin - 3.0 x 3.0 m - with a double door to the front

Radnor 3 Log Cabin - 3.0 x 4.5 m - with a double door to the front and a side store with solid door

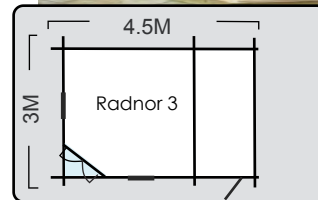
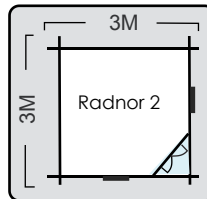
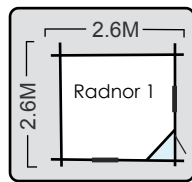

The Radnor 3 is also available in 40mm logs

## Newport Hexagonal Cabin

A hexagonal summerhouse - a beautiful addition to any garden. Constructed from 28mm logs with roofing felt as standard. The Newport comes complete with double opening doors and single top opening windows in single glazing.

3.5M Diameter - 28mm Logs

3.36M high to apex

Add shingles as an extra

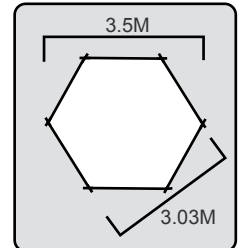

## Lydford Summerhouse

A variation on the traditional square log cabin. The Lydford Log Cabin is a pretty summerhouse made from 28mm logs. The Lydford comes with fully glazed double doors to the front.

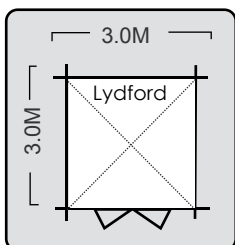

3.0m x 3.0m in 28mm Logs

Add Shingles, floor insulation and windows as extras



## Newark Shelter

A great shelter for any garden, or to house a hot tub. A pressure treated decked floor is provided as part of the kit as standard.. Other sizes available on request.

3.2m x 3.2m in 28mm Logs



# 28MM Log Cabins

**Beautiful summerhouses, garden offices, extra space or play room.** Made from 28mm log thickness, extra doors and windows can be fitted or perhaps a terrace to make these cabin as individual as your needs are. Windows and doors are single-glazed with the doors right hand hinged and windows are top hinged. The buildings come with tongue & grooved 19mm floor & roof and they come with green mineral roofing felt as standard or upgrade to roofing shingles. All our 28mm buildings are 2.57m high and 2.05m to the eaves with a 0.7m overhang unless stated.



The Dudley comes with a half-glazed door & single window. A double side window comes as standard with the larger sizes. An optional terrace to the front of the building is available in 1.2m or 1.5m depths.

## Dudley

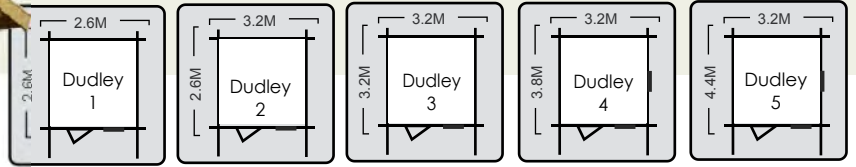

Building	Dudley 1	Dudley 2	Dudley 3	Dudley 4	Dudley 5
<b>Width x Length</b>	<b>2.6 x 2.6</b>	<b>3.2 x 2.6</b>	<b>3.2 x 3.2</b>	<b>3.2 x 3.8</b>	<b>3.2 x 4.4</b>
<b>Included extras</b>				Double Side window	Double Side window
<b>Roof Shingles</b>	As extra	As extra	As extra	As extra	As extra
<b>Floor Insulation</b>	As extra	As extra	As extra	As extra	As extra
<b>Roof Insulation</b>	As extra	As extra	As extra	As extra	As extra
<b>1.2m Terrace</b>	As extra	As extra	As extra	As extra	As extra
<b>1.5m Terrace</b>	As extra	As extra	As extra	As extra	As extra

Add an extra top-hinged window

## Orford

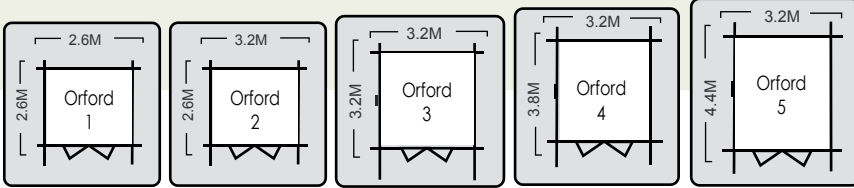

Building	Orford 1	Orford 2	Orford 3	Orford 4	Orford 5
<b>Width x Length</b>	<b>2.6 x 2.6</b>	<b>3.2 x 2.6</b>	<b>3.2 x 3.2</b>	<b>3.2 x 3.8</b>	<b>3.2 x 4.4</b>
<b>Included extras</b>			Single Side Window	Double Side window	Double Side window
<b>Roof Shingles</b>	As extra	As extra	As extra	As extra	As extra
<b>Floor Insulation</b>	As extra	As extra	As extra	As extra	As extra
<b>Roof Insulation</b>	As extra	As extra	As extra	As extra	As extra
<b>1.2m Terrace</b>	As extra	As extra	As extra	As extra	As extra
<b>1.5m Terrace</b>	As extra	As extra	As extra	As extra	As extra



Double Half glazed doors make it easy for storage. A side single or double opening window is included on the larger models of the Orford.

Add an extra top-hinged window

## Warwick

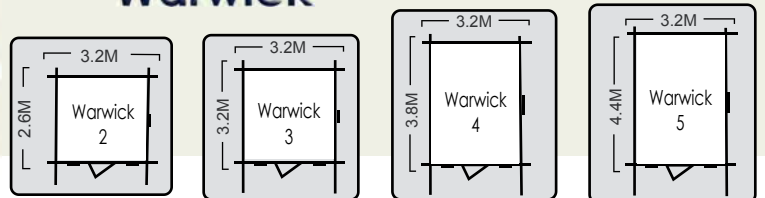

Building	Warwick 2	Warwick 3	Warwick 4	Warwick 5
<b>Width x Length</b>	<b>3.2 x 2.6</b>	<b>3.2 x 3.2</b>	<b>3.2 x 3.8</b>	<b>3.2 x 4.4</b>
<b>Included extras</b>	Single Side Window	Single Side Window	Double Side window	Double Side window
<b>Roof Shingles</b>	As extra	As extra	As extra	As extra
<b>Floor Insulation</b>	As extra	As extra	As extra	As extra
<b>Roof Insulation</b>	As extra	As extra	As extra	As extra
<b>1.2m Terrace</b>	As extra	As extra	As extra	As extra
<b>1.5m Terrace</b>	As extra	As extra	As extra	As extra



Comes with single half-glazed door, two single windows to the front & one window to side.

Add an extra top-hinged window

# 28MM Log Cabins

## Berwick



All windows are top-hinged & not as illustrated

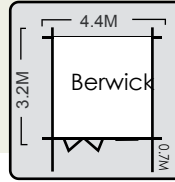
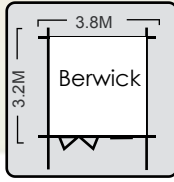

The Berwick & Berwick Log Cabins give you large space at an affordable price. Both log cabins come with double doors to the front of the building. The Berwick has a top-hinged single window to the front whilst the Berwick has a set of double windows to the front.

Add an extra top-hinged window

Building	Berwick 1	Berwick 2
<b>Width x Length</b>	<b>3.8 x 3.2</b>	<b>4.4 x 3.2</b>
<b>Included doors &amp; windows</b>	Single Window & Double Door	Double Window & Double Door
<b>Roof Shingles</b>	As extra	As extra
<b>Floor Insulation</b>	As extra	As extra
<b>Roof Insulation</b>	As extra	As extra
<b>1.2m Terrace</b>	As extra	As extra
<b>1.5m Terrace</b>	As extra	As extra

## Pembroke



Add an extra top-hinged window

The Pembroke is an attractive alternative to the usual apex style log cabins. Comes with one side window and double doors to front. **Other sizes available on request.**

Building	Pembroke
<b>Width x Length</b>	<b>3.2 x 2.6</b>
<b>Included doors &amp; windows</b>	Single Window & Double Door
<b>Roof Shingles</b>	As extra
<b>Floor Insulation</b>	As extra
<b>Roof Insulation</b>	As extra
<b>1.2m Terrace</b>	As extra
<b>1.5m Terrace</b>	As extra

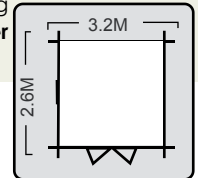

2.39M high to front  
No overhang

## Workshops

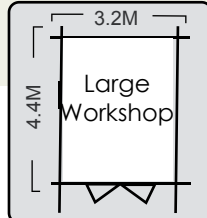
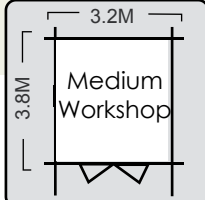
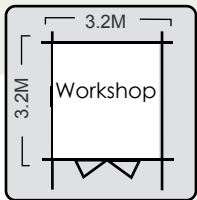

All windows are top-hinged



Our workshops come complete with a set of solid double doors for ease of access & security and one window to side.

Add an extra top-hinged window

Building	Workshop 1	Medium Workshop 2	Large Workshop 3
<b>Width x Length</b>	<b>3.2 x 3.2</b>	<b>3.2 x 3.8</b>	<b>3.2 x 4.4</b>
<b>Included doors &amp; windows</b>	Single Window & Solid Door	Double Window & Solid Door	Double Window & Solid Door
<b>Roof Shingles</b>	As extra	As extra	As extra
<b>Floor Insulation</b>	As extra	As extra	As extra
<b>Roof Insulation</b>	As extra	As extra	As extra



Add a Terrace  
Available in  
standard  
or customised sizes

**Additional 28mm Single Glazed Doors**

# 44mm Log Cabins

Made from 44mm log thickness these substantial log cabins make great garden offices or garden rooms. Windows and doors are double-glazed as standard. The windows come with an aluminium weather seal and are tilt & turn inward opening. The single doors are right hand hinged and both doors come with a stainless steel door trim. You can opt to insulate floors & roofs for greater comfort. All buildings come with green mineral roofing felt as standard or upgrade to roofing shingles to fit beautifully into your garden. All buildings come with a 1.2m overhang except the Kendal.

## Bedford

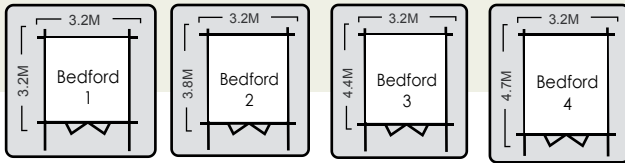

**Double Glazed**  
as standard

The Bedford has half-glazed double doors to the front & comes in four sizes. An optional terrace is available 3.2 x 1.5m

Building	Bedford 1	Bedford 2	Bedford 3	Bedford 4
<b>Width x Length</b>	<b>3.2 x 3.2</b>	<b>3.2 x 3.8</b>	<b>3.2 x 4.4</b>	<b>3.2 x 4.7</b>
<b>Doors &amp; Windows included</b>	Double Door	Double Door	Double Door	Double Door
<b>Roof Shingles</b>	As extra	As extra	As extra	As extra
<b>Floor Insulation</b>	As extra	As extra	As extra	As extra
<b>Roof Insulation</b>	As extra	As extra	As extra	As extra
<b>Terrace</b>	As extra	As extra	As extra	As extra

## Leeds

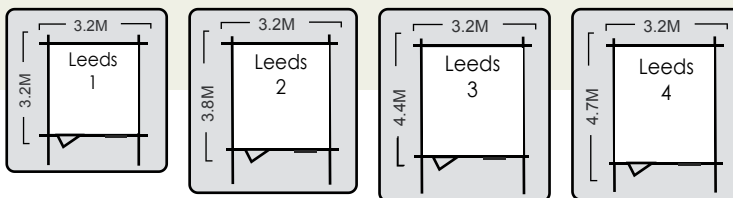

**Double Glazed**  
as standard

The Leeds has a single door & window to the front. An optional terrace is available 3.2 x 1.5m.

Building	Leeds 1	Leeds 2	Leeds 3	Leeds 4
<b>Width x Length</b>	<b>3.2 x 3.2</b>	<b>3.2 x 3.8</b>	<b>3.2 x 4.4</b>	<b>3.2 x 4.7</b>
<b>Doors &amp; Windows included</b>	Single Door & Single window	Single Door & Single window	Single Door & Single window	Single Door & Single window
<b>Roof Shingles</b>	As extra	As extra	As extra	As extra
<b>Floor Insulation</b>	As extra	As extra	As extra	As extra
<b>Roof Insulation</b>	As extra	As extra	As extra	As extra
<b>Terrace</b>	As extra	As extra	As extra	As extra

## Richmond

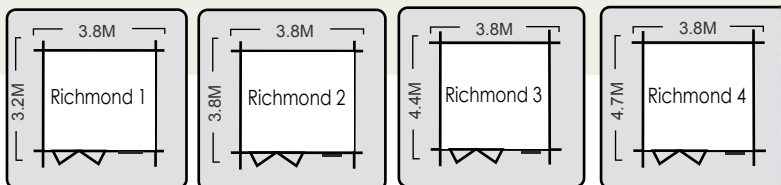

**Double Glazed**  
as standard

The Richmond comes with a double door and single window to the front. An optional terrace is available 3.8 x 1.5m.

Building	Richmond 1	Richmond 2	Richmond 3	Richmond 4
<b>Width x Length</b>	<b>3.8 x 3.2</b>	<b>3.8 x 3.8</b>	<b>3.8 x 4.4</b>	<b>3.8 x 4.7</b>
<b>Doors &amp; Windows included</b>	Double Door & Single window	Double Door & Single window	Double Door & Single Window	Double Door & Single Window
<b>Roof Shingles</b>	As extra	As extra	As extra	As extra
<b>Floor Insulation</b>	As extra	As extra	As extra	As extra
<b>Roof Insulation</b>	As extra	As extra	As extra	As extra
<b>Terrace</b>	As extra	As extra	As extra	As extra

# 44mm Log Cabins

## Harlech

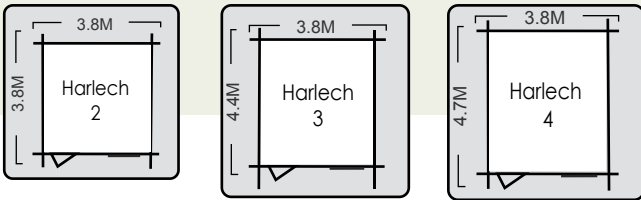

**Double Glazed**  
as standard

Please note that the windows are now inward opening tilt & turn

The Harlech has a single door and double window to the front. An optional terrace is available 3.8m x 1.5m

Building	Harlech 2	Harlech 3	Harlech 4
Width x Length	3.8 x 3.8	3.8 x 4.4	3.8 x 4.7
Doors & Windows included	Single Door & Double Window	Single Door & Double Window	Single Door & Double Window
Roof Shingles	As extra	As extra	As extra
Floor Insulation	As extra	As extra	As extra
Roof Insulation	As extra	As extra	As extra
Terrace	As extra	As extra	As extra

## Balmoral

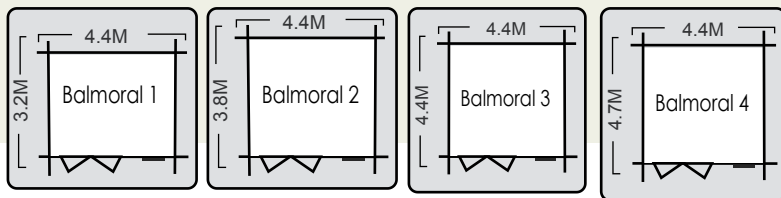

**Double Glazed**  
as standard

The Balmoral Log Cabin has a double door and double windows to the front.

An optional terrace is available 4.4m x 1.5m

Building	Balmoral 1	Balmoral 2	Balmoral 3	Balmoral 4
Width x Length	4.4 x 3.2	4.4 x 3.8	4.4 x 4.4	4.4 x 4.7
Doors & Windows included	Double Door & Double Window	Double Door & Double Window	Double Door & Double Window	Double Door & Double Window
Roof Shingles	As extra	As extra	As extra	As extra
Floor Insulation	As extra	As extra	As extra	As extra
Roof Insulation	As extra	As extra	As extra	As extra
Terrace	As extra	As extra	As extra	As extra

## Kendal



**Double Glazed**  
as standard

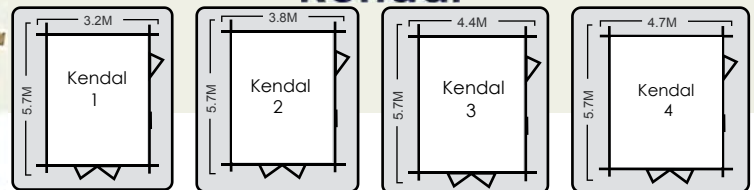

Please note the drawings above show the standard position for doors & windows. Please ask for other options.

The Kendal comes with a double door, single door & Double window as standard

**Double your space**



Join two Kendal buildings together

Building	Kendal 1	Kendal 2	Kendal 3	Kendal 4
Width x Length	3.2 x 5.7	3.8x 5.7	4.4 x 5.7	4.7 x 5.7
Included	Double Door, Single Door & Double Window	Double Door, Single Door & Double Window	Double Door, Single Door & Double Window	Double Door, Single Door & Double Window
Roof Shingles	As extra	As extra	As extra	As extra
Floor Insulation	As extra	As extra	As extra	As extra
Roof Insulation	As extra	As extra	As extra	As extra
Terrace	As extra	As extra	As extra	As extra

### Additional 44mm Double Glazed Doors & Windows

Single Window	Double Window	Single Door	Double Door
As extra	As extra	As extra	As extra

# 70mm Log Cabins

These beautiful log cabins make fantastic **Garden Offices**. Constructed from 70mm thick logs, they offer superb quality and comfort. Double glazed as standard throughout, the buildings are **exceptional quality at an affordable price**. The windows and doors are constructed from laminated timber and fitted with stainless steel trim. The windows are tilt & turn allowing you to ventilate the building without leaving the windows wide open. All 70mm Log Cabins have 19mm thick roof boards & floorboards as standard. The buildings are 2.9m to the height.

## Southwold 1

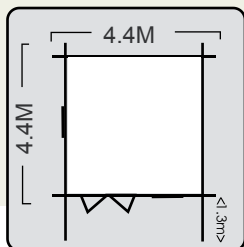

**Double Glazed**  
as standard

Building	Southwold 1
Width x Length	4.4 x 4.4
Included doors & windows	2 Double Windows & Double Doors
Roof Shingles	As extra
Floor Insulation	As extra
Roof Insulation	As extra
2m Terrace	As extra

A lovely chalet style cabin. Perfect for working from home or simply as a garden room.



**Double Glazed**  
as standard

Made from 70mm Logs the Log Cabin comes complete with two single windows at the front and a double window at the side.

## Southwold 2

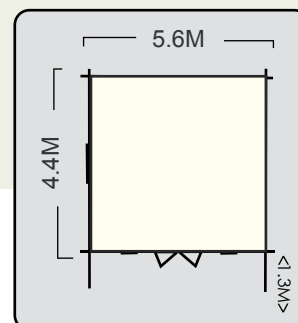

Building	Southwold 2
Width x Length	5.6 x 4.4
Included doors & windows	1 Double Windows, 2 Single Windows & Double Doors
Roof Shingles	As extra
Floor Insulation	As extra
Roof Insulation	As extra
2m Terrace	As extra

## Customise

Do you want to have a different window or door combination  
Do you want the building without an overhang?



# 70mm Log Cabins

## Stirling

The Stirling is guaranteed to offer you **exceptional quality at incredible value for money.** Constructed from 70mm logs and creating nearly 30 square metres of floor space.

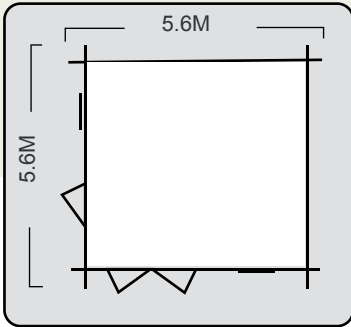

**Double Glazed**  
as standard



Building	Stirling
Width x Length	5.6 x 5.6
Included doors & windows	2 Double Windows, 1 Single Door & 1 Double Door
Roof Shingles	As extra
Floor Insulation	As extra
Roof Insulation	As extra
2m Terrace	5.6m - As extra

### Do you require a larger building

The Stirling can be extended in blocked units. Internal room partitions can be added and Windows & doors added both internally & externally

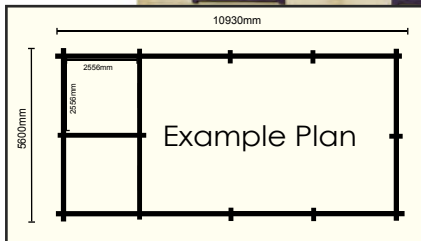

## Doors & Windows

### Standard Doors & Windows



Double Glazed Doors & Windows  
Tilt & Turn, inward opening windows  
With aluminium gutter  
Doors with stainless steel door trim

Standard Double Glazed Doors & Windows			
Single Window	Double Window	Single Door	Double Door

# Garages

## Single Garages

Impressive to look at but practical too. The large front opening garage doors are ledged and braced with internal top and bottom bolts. There is no floor in the Garage so it is strongly recommended that a substantial concrete base is laid. Made from 44mm logs, we offer four sizes in the single garage and an optional partition wall. Additional doors and windows can be added if required. The garages are single glazed as standard but you can add double glazing as an optional extra. Please note that they now come with 6 galvanised hinges as standard. The single glazed windows are top hinged.

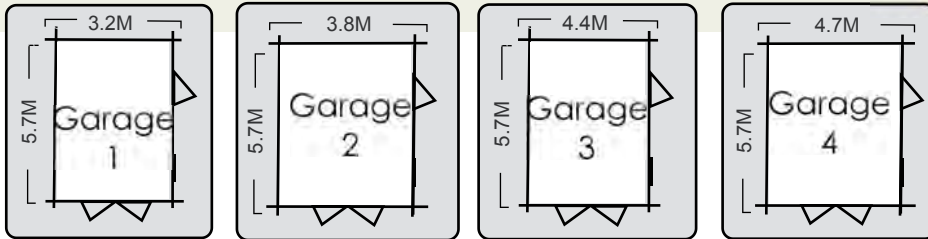

**Double your space**

Join two garages together to increase your space!

Building	Garage 1	Garage 2	Garage 3	Garage 4
<b>Width x Length</b>	<b>3.2 x 5.7</b>	<b>3.8 x 5.7</b>	<b>4.4 X 5.7</b>	<b>4.7 x 5.7</b>
<b>Doors &amp; Windows included</b>	Garage Door, Single Door & Double Window	Garage Door, Single Door & Double Window	Garage Door, Single Door & Double Window	Garage Door, Single Door & Double Window
<b>Roof Shingles</b>	Avaiable as extra	Avaiable as extra	Avaiable as extra	Avaiable as extra
<b>Partition Walls</b>	Avaiable as extra	Avaiable as extra	Avaiable as extra	Avaiable as extra

3.02M(H) to ridge



## Double Garage

Two sets of garage doors, both fitted with internal top & bottom bolts and hasp & staples. Please note that they now come with 6 galvanised hinges as standard. The Double Garage is constructed from 70mm logs and provides just under 30 square metres of floor space, giving ample room for parking and storage. The Double Garage is supplied without a floor. Windows & doors are single glazed. Please note that doors may be supplied without curved fascia as illustrated.

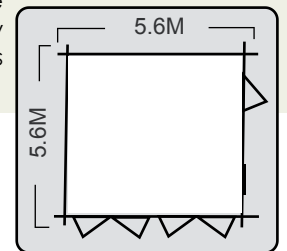

Building	Double Garage
<b>Width x Length</b>	<b>5.6 x 5.6</b>
<b>Doors &amp; Windows included</b>	2 Garage Doors, Single Door, Double Window
<b>Roof Shingles</b>	Avaiable as extra

3.04M(H) to ridge  
**70mm Logs**

## Up & Over Garage Doors

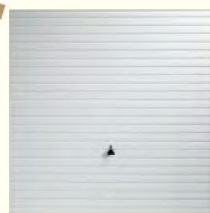

Horizon

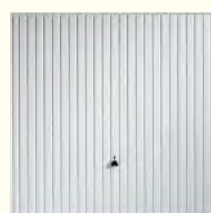

Carlton

Will fit both single & double garages.  
AVAILABLE IN CHOICE OF BROWN OR WHITE.  
With black handle option. Brush trim available.

Available as an extra

# Extras for Log Cabins

## ROOF SHINGLES

Shingle felt roofing tiles are an attractive alternative to the Green Mineral Roofing felt. They are manufactured from a combination of bitumen and bitumen impregnated fibre glass topped with high quality aggregates. They withstand wind, rain, snow and temperature extremes without deterioration.



## Customising your building

We can offer a range of options if you require a slightly different building to those in the brochure



- Windows & Doors can be added or placed in different positions
- Using the standard log sizes we can also offer different combinations of buildings to those in the brochure e.g. If you require a 44mm log cabin 5.7m wide and 4.4m deep.
- We can offer a pent roof style in many of the log cabins
- We can adjust the height of the building if necessary for planning purposes.

## Extra Logs

Additional logs can be purchased e.g. to increase the height of your building. Additional logs are available:

- 28mm Logs  
In 2.6M, 3.2M, 3.8M & 4.4M lengths
- 44mm Logs  
In 3.2M, 3.8M, 4.4M, 4.7M & 5.7M lengths
- 70mm Logs  
In 4.4M & 5.6M lengths

# CabinSystems2014



## Midgley Centre

Stocksmoor Road,  
Midgley,  
Wakefield,  
WF4 4JG

[sales@jobearnshaw.co.uk](mailto:sales@jobearnshaw.co.uk)

01924 830055

## Wentworth Centre

Barrowfield Lane,  
Wentworth,  
Rotherham,  
S62 7TP

[sales@jobearnshaw.co.uk](mailto:sales@jobearnshaw.co.uk)

01226 742206

## Brigg Centre

Bridge Street,  
Brigg  
North Lincolnshire,  
DN20 8NQ

[sales@jobearnshaw.co.uk](mailto:sales@jobearnshaw.co.uk)

01652 653165



[www.jobearnshaw.co.uk](http://www.jobearnshaw.co.uk)